

Data sheet



Article:
61-0548-0591

1. Technical information

Magnet type	Holding magnet
Material	Neodymium / Rubber Coated
Strength [N]	240
Shear force [N]	90
Length L [mm]	59
Width B [mm]	45
Thickness T [mm]	8.5
Inner Ød [mm]	5.5
Inner Ød2 [mm]	12
Weight [g]	79
Max temp. [°C]	80
Color	Black

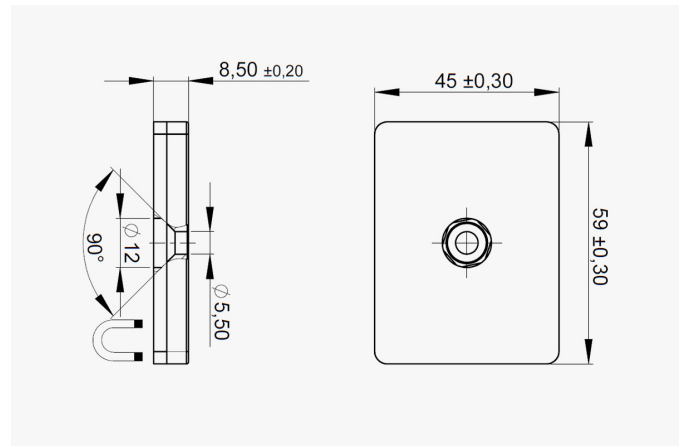

Product compliant with the latest European RoHS directive.



Product compliant with the latest European REACH regulation.

2. Safety tips



Swallowing

Swallowing magnets is dangerous, since they could get stuck in the intestine and cause harmful complications. Magnets are not toys for small children! Make sure that children don't play with magnets.



Pacemaker

Magnets could affect the functioning of pacemakers and implanted heart defibrillators.

- A pacemaker could switch into test mode and cause illness.
- A heart defibrillator may stop working.
- If you know anyone with these devices, inform them about not getting too close to magnets.

You can find all information about how magnet affects pacemakers on our website, under magnet facts.



Drop / release risk

Too heavy loads, fatigue as well as material defect could cause a magnet to reluctantly release from the surface that it was attached to. Falling objects could lead to serious injuries.

Falling objects could lead to serious injuries.

- The indicated adhesive force applies only to ideal conditions. Allow for a high safety cushion.
- Don't use magnets in places where people could sustain injuries in case of material failure.



Crush hazard

Large magnets have a very strong attractive force.

- Unsafe handling could cause jamming of fingers or skin in between magnets. This may lead to contusions and bruises.

- Powerful, very large magnets could cause bone fractures.



Metal splinters

Neodymium magnets easily shatter. Colliding magnets could crack.

When a magnet shatters, pieces could come flying with high speed, injuring you or others.

- Avoid hard collision of magnets.
- Wear safety glasses / other protection when handling larger magnets.

3. Handling and storing



Magnetic field

Magnets magnetic field can reach far and could have an impact or even damage your electronics. Strong magnetic fields from neodymium magnets can damage magnetic media such as credit cards, magnetic ID-cards, video-tapes, TVs, computer screens and other CRT-screens. For smaller electronics such as mobile-phones, ipods, calculators and other devices that do not contain magnetic storage, a magnet should do no harm. See more info on our FAQ-page.



Flammable

When machining magnets, the drilling dust will get warm and could easily ignite.

Stay away from machining magnets or use appropriate tools and sufficient cooling water.

Also we do not recommend machining neodymium magnets. The material is very hard and brittle and all kinds of machining can damage the magnet. Heat produced by processing can quickly demagnetize the magnet.



Toxic / nickel allergy

The majority of our magnets contain nickel (also those without nickel coating).

- Those who are allergic to nickel can get an allergic reaction when they come into contact with it.
- Nickel allergies could develop from repeated contact with nickel-plated objects. Thus avoid this.
- Avoid contact with magnets if you already have a nickel allergy.



Influence on people

There are no known health risks caused by being exposed to neodymium magnets (except for people with pacemaker, read above or our FAQ for info about magnets impact on pacemakers). Some people actually believe magnets can have health benefits and help the healing process. There are currently no scientific studies that prove this however. Large and strong magnets can cause physical harm if not handled properly.



Oxidation, corrosion, rust

Untreated neodymium magnets oxidise quickly and disintegrate.

Most of our magnets have a nickel-copper-nickel coating to protect them from corrosion. This coating provides some protection against corrosion, but it is not robust enough for continuous outdoor use.

- Use magnets only in the dry indoors or protect them against environmental influences.
- Avoid damages to the coating.



Temperature resistance

Neodymium magnets have a maximum working temperature of 80°C (up to 230°C, depending on your specification) Most neodymium magnets lose part of their adhesive force permanently at its highest specified working temperature (most common: 80°C). See all our different neodymium grades and max working temperatures at www.hyab.com

- Don't use magnets in places where they are exposed to extreme heat.
- If you use an adhesive, don't harden it with hot air.



Mechanical treatment

Machining magnets can be a tricky process and we do not recommend it unless there is no other option. Neodymium magnets are very hard and brittle and any kind of machining can break or damage the magnet. Heat produced by machining can quickly demagnetize the magnet.

4. Transportation tips



Airfreight

Magnets and magnetic devices can be shipped by air if the following criteria are met: "For carriage by aircraft, any package which has a magnetic field of more than 0.00525 gauss measured at 4.5 m (15 feet) from any surface of the package. To meet these requirements, you might have to pack your magnets with sufficient magnetic shielding. This is done by placing iron inside the package on all sides. The bigger magnets, the thicker iron plate as shielding. If these requirements are not met, the package is identified as **Hazardous Material** acc. **UN2807**. It is then up to the airline how the goods should be handled.



Postage

We ship all of our magnets carefully packed. Like with airfreight it is important to shield the box so any magnetic field doesn't leak. We Place the article in the middle of the box with a lot of padding material around. If it is many strong magnets or magnets in large dimension - we shield the package. This is done by placing iron inside the package on all sides. The bigger magnets, the thicker iron plate as shielding.

5. Disposal tips



Recycle

In Sweden, magnets are sorted as scrap metal. All scrap metal is handed over to the recycling centre. This may change depending on the country you are in. Check your country's regulations on how to properly recycle magnets.